

RALEIGH

INSTRUCTION MANUAL



It is important for you, or any rider of the bicycle, to read this manual before your first ride – even if you are an experienced cyclist.

www.raleighintl.com

RALEIGH WARRANTY PROCEDURE

- Your Raleigh bicycle frame has a lifetime warranty and all other parts have a 6-month warranty for any structural defect in material and workmanship from the date of purchase. The warranty is limited to the first purchaser of the product and transfer of the product from the first owner to another person terminates the warranty.
- In order to claim on a warranty, the owner must retain their proof of purchase and return the bicycle to the store where purchased.
- Warranty does not cover the following:
 - 1) Punctured or cut tyres and tubes
 - 2) Buckled wheels
 - 3) Brake and gear settings
 - 4) Broken Chain
 - 5) Accident damage
 - 6) Abuse, negligence or any other external factor that may cause damage or cause the bicycle to not work properly
 - 7) Improper assembly
- It is advised that the bicycle be assembled by a professional or a Raleigh technician where available.
- Bicycles that are taken out of a box for assembly require gears and brakes to be set before they can be ridden safely.
- It is the customer's responsibility to ensure that this is done as any maintenance problem arising from self-assembly is NOT covered under warranty.

To register your bicycle and log a warranty please upload the below link. Please feel free to contact our Raleigh service centre on 011 393 1122 ext. 2000 or 010 590 6347

<https://raleighintl.com/support/>

TOOLS REQUIRED

Your new bike will require tools for assembly. Please read the manual before assembly to ensure that the bicycle is safe to ride.

The tools required are as follows,



Shifting spanner



Open ended Spanners

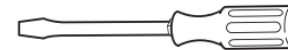

Flat-blade Screwdriver

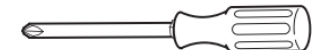

Phillips Screwdriver



Universal pliers



Metric Allen Keys

The tools required may vary per model of bike you have purchased. Most bikes will use the following tools,

- Universal pliers
- 12/13/14/15 spanners
- Philips screwdriver
- 4/5/6 Allen keys
- Shifting spanner

ASSEMBLY INSTRUCTIONS

Assemble the front wheel

- If the Axle Nuts (1) are already attached to the front wheel axle, begin by removing them with an open-end spanner or adjustable wrench.
- Set the wheel into the front fork (2) and ensure the wheel is in the centre of the fork.
- Install wheel retainers (3) making sure the tabs are in the fork (4) tab holes.
- Attach the front wheel with the Axle Nuts.
- Tighten Axle Nuts to 28nm

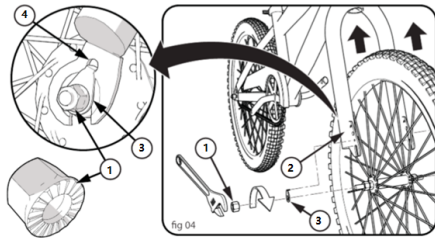

Handlebar and handlebar stem assembly

- Remove the plastic cover from the stem quill. (7)
- Insert handlebar stem (9) into frame making certain that the minimum insertion line (6) is not visible above the lock ring. (10)
- Line up the handlebar stem with the front wheel.
- Ensure that the brakes are facing the front of the bike.
- Tighten expander bolt securely. (8)
- Position handlebar at desired angle. (11)
- Fasten the handlebar stem on handlebar. (5)

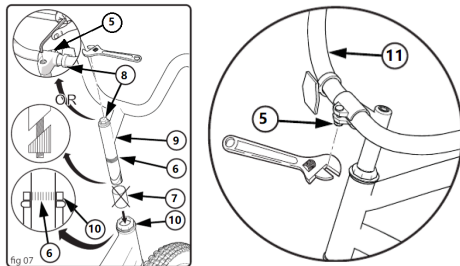

Saddle assembly

- Attach the saddle (12) to the seat post (13) and tighten the seat post clamp (14) evenly on each side.
- Open the quick release clamp. (15)
- Point saddle forward and insert the seat post into the seat tube.(16)
- Make sure the saddle is level to the ground
- The minimum insert mark (17) on the seat post must be below the top of the seat tube.(16)
- Tighten the quick release clamp (15)

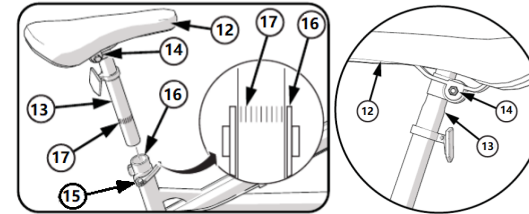

Pedal assembly

Left and right pedals are **not** interchangeable and have different thread. Warning: forcing a wrong pedal on the pedal arms will strip threads requiring new parts.

- The right pedal marked "R" goes in the pedal arm on the right side (chain side). Turn right pedal (by hand) in clockwise direction.
- The left pedal marked "L" goes in the pedal arm on the left side of the bicycle. Turn right pedal (by hand) in counter clockwise direction.
- Tighten securely with an adjustable wrench.

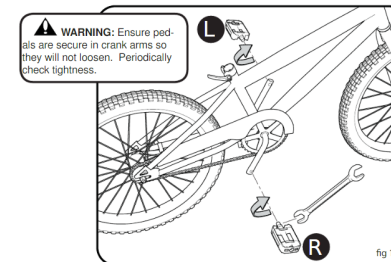

Brake adjustment

R

- Loosen the Screw (24) of each Brake Shoe (22)
- Adjust each brake Shoe (22) so it is flat against the rim (23) and aligned with the curve of the rim.
- Make sure each brake Shoe (22) does not rub the tyre. (25)
- Hold each brake Shoe in position and tighten the screw. (24)
- To adjust the brakes, (28) loosen the cable fixing bolt (26), pull the cable (27) using the pliers and make sure the brake pads have 2mm clearance between each brake pad (22) and the rim (23), tighten the cable fixing bolt.

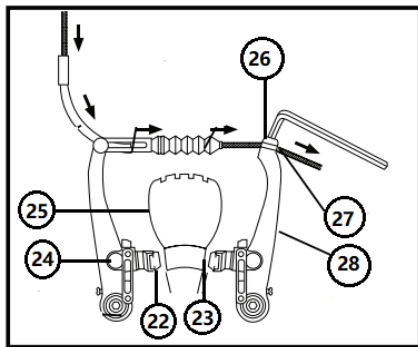

Thanking- you

Thank-you for buying a Raleigh and welcome to an enjoyable riding experience built on a brand with a rich heritage.

Your Raleigh is designed with your enjoyment in mind and is built with quality components throughout.

We are sure you'll be 100% satisfied with the performance of your new bike. If you need help at any time, please get in touch with your Raleigh dealer who will be happy to help.

Remember cycling is all about fun – enjoy!

General warning and safety advice

- Cycling can be a hazardous activity even under the best of circumstances. Proper maintenance of your bicycle is your responsibility as it helps reduce the risk of injury.
- It is compulsory to wear a cycling standards approved helmet while cycling.
- We recommend you use only authorised components or accessories to ensure your safety.